

# MULTI PLAY MODE

Multi mode allows the TG77 to function as sixteen completely independent synthesizers. In multi play mode you can do the following things.

- Select multis from preset, internal, or card memory.
- View a directory of the 16 multis in an internal, card, or preset memory.
- Copy the currently selected multi to any internal or card memory.

## MULTI PLAY MODE

Multi mode allows the TG77 to function as sixteen completely independent synthesizers, each being controlled on its own MIDI channel.

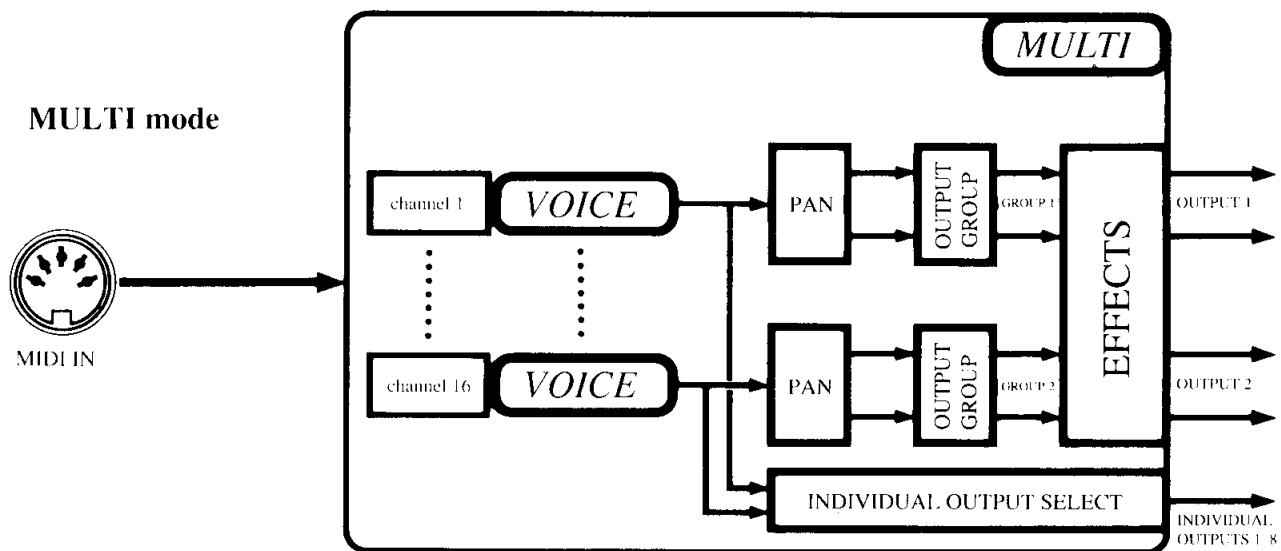

## Multi select

JUMP #300

Press MULTI to enter multi play mode. The following LCD will appear.

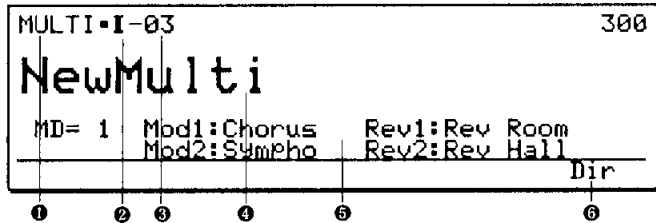

- ❶ MULTI: This indicates that you are in Multi Play mode.
- ❷ Multi memory (I, C, P): This indicates the multi memory; Internal, Card, or Preset. Preset memory contains only a single bank of 16 Multis.

- ❸ Multi number (1–16): This indicates the number of the multi.
- ❹ The Multi name is displayed in large characters.
- ❺ Effect settings: The effect mode is indicated as “MD=”, and the type of effect selected by this multi is shown for each of the four DSP units; Modulation 1 and 2, and Reverb 1 and 2. For details refer to *Multi Edit mode, job 7. Effect set.*
- ❻ Refer to the following section *Multi Directory*.

To select a multi, press MEMORY to select internal, card, or preset multis. Then use the -1 +1 keys or the numeric key pad to select a multi 1–16.

## Multi directory

JUMP #301

**Summary:** While in multi play mode you can press F8 (Dir) to view a directory of the sixteen multis in the currently selected multi memory. The following display will appear.

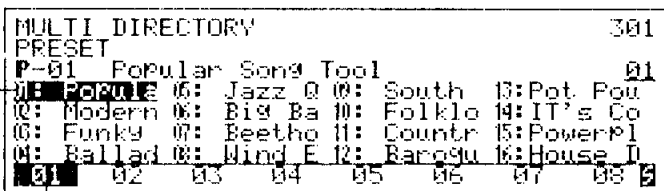

- ❶ The first seven characters of each twenty-character multi name will be displayed. When you select a different multi memory (internal, card, or preset) the sixteen multis in the newly selected memory will be displayed. In addition to the usual methods of selecting a multi, you can also use the arrow keys to select a multi.
- ❷ Pressing F1–F8 (01)–(08) will select a multi 1–8 from the displayed multi directory. Holding SHIFT and pressing F1–F8 (09)–(16) will select a multi 9–16.

To return to the multi play display with the name of the selected multi displayed in large characters press EXIT.

## Copy multi

**Summary:** Anytime in multi play mode you can copy the currently selected multi to another multi memory.

**Procedure:**

From: multi play mode (JUMP #300, #301)

Press: COPY

Specify: the destination to which the multi will be copied.

To execute: the copy operation press F8 (Go).

To quit: without executing press EXIT.

```
COPY MULTI
P-01 Popular Song Tool
INTERNAL
01: Popula 06: Jazz 09: South 13: Pot. Pou
02: Modern 08: Big Ba 10: Folklo 14: IT's Co
03: Funky 07: Beetho 11: Countr 15: PowerP1
04: Ballad 05: Mind E 12: Raposu 16: House D
Go
```

The names of the sixteen multis in Internal or Card memory are displayed as explained in *Multi Directory*. Press MEMORY to select internal or card memory, and use -1 +1 or the numeric keypad to specify a copy destination 1-16.

After specifying the copy destination press F8 (Go). You will be asked "Are you sure?" If you are sure you want to copy the multi, press YES and the data will be copied. To quit without copying press NO.

*Note:* If you copy a multi from internal memory to card memory, all internal voice numbers used by that multi will be converted into card voice numbers. In the same way, if you copy a multi from card memory to internal memory, all card voice numbers used by that multi will be converted into internal voice numbers.

# MULTI EDIT MODE

This section explains the details of all Multi Edit parameters.

## MULTI EDIT MODE

**From multi play mode press EDIT to enter multi edit mode. Unlike voice edit mode, multi edit mode has only a single job directory.**

## Compare

When you are in edit mode but have not yet modified the data, a small square ■ is displayed at the left of the multi number to indicate that the voice has not yet been edited. If the data is edited in any way, this will change to an inverse "E".

The multi has been edited

```

VOICE SELECT                                401
MULTI ■ I-03 NewMulti
Selected Voice=PI-A16(16) AP:Grand
01: PA: Grand 05: [off] 09: [off] 13: [off]
02: BA: Wood 06: [off] 10: [off] 14: [off]
03: WN: Alto 07: [off] 11: [off] 15: [off]
04: [off] 08: [off] 12: [off] 16: DR: Grow
On Off Ret Mon Mode Dir Edit
  
```

If you want to see and hear the original data press EDIT (COMPARE) and the inverse "E" will change to a "C" indicating that you are in compare mode. To return to edit mode, press EDIT (COMPARE) once again and the "C" will change back to an "E".

*Note: While comparing, the mode select keys, the cursor keys, EXIT, PAGE, JUMP, COPY, and some of the F1-F8 keys will not function.*

## Store multi

When you press EXIT or use the JUMP button to exit Multi Edit mode after editing the data, the top line of the display will ask "AUTO-STORE MULTI".

```

AUTO-STORE MULTI
■ I-03 NewMulti
INTERNAL                                03
01: Popula 05: Jazz Q 09: South 13: Pot Pou
02: Modern 06: Big Ba 10: Folklo 14: IT's Co
03: Rock 07: Beetho 11: Countr 15: PowerPl
04: Ballad 08: Wind E 12: Baroqu 16: House D
Ret Quit Go
  
```

The LCD will show the first seven characters of the multi names in the currently selected internal or card multi memory. The multi name displayed in inverse indicates the multi memory into which the edited data will be stored.

1. Press MEMORY to specify the multi memory, and select the multi memory 1-16 in which you want to store your newly edited multi.
2. Press F8 (Go), and the bottom line will ask "Are you sure ? (Yes or No)".
3. If you are sure you want to store the edited multi, press +1/YES and the bottom line of the LCD will show "Store completed". If you decide not to store, press -1/NO to return to the store destination select display.
4. You will then return to multi play mode or the jump destination.

## Multi edit job directory

JUMP #400

**Summary:** The parameters of Multi Edit mode are divided into the jobs shown in this job directory.

**Procedure:**

- From: multi play mode (JUMP #300)  
 Select: EDIT (JUMP #400)  
 Specify: the desired multi edit job and press ENTER.

```

MULTI EDIT                                400
■ I-03 NewMulti                                01
01: Voice 05: St-Pan 09: IndOut 13: -----
02: Volume 06: OutSel 10: Assign 14: -----
03: Tuning 07: Effect 11: ----- 15: Initlz
04: Shift 08: Name 12: ----- 16: Recall
01 02 03 04 05 06 07 08 9
  
```

- 1 This area shows the number and name of the selected multi.

## MULTI EDIT MODE

- ② Move the cursor in this area to select a job and press ENTER to go to the selected job.
- ③ Pressing F1–F8 will select the corresponding job 1–8. Holding SHIFT and pressing F1, F2, F7 or F8 will select job 9, 10, 15 or 16.

- 01: Voice (Voice Select): A multi consists of sixteen voices which are controlled by MIDI channels 1–16. A different voice can be selected for each of the sixteen channels in the multi.
- 02: Volume (Voice Volume): The volume of the voice played by each channel of the multi can be adjusted.
- 03: Tuning (Voice Tuning): The fine tuning of the voice played by each channel of the multi can be adjusted in steps of 1.1718875 cents.
- 04: Shift (Voice Note Shift): The pitch of the voice played by each channel of the multi can be adjusted in half steps.
- 05: St-Pan (Voice Static Pan): A fixed stereo position can be specified for the voice played by each channel of the multi, or a voice can use its own pan settings.
- 06: OutSel (Voice Output Select): All voices played by the multi are sent from output groups 1 and/or 2 to the effect unit. The

selected output group determines how the voice will be processed through the effect unit.

- 07: Effect (Effect Set): The four effects in the effect unit can be arranged in various ways to add modulation and reverb to the sound.
- 08: Name (Name Multi): The multi being edited can be given a twenty-character name. In multi play mode this name will be displayed in large characters.
- 09: IndOut (Individual Output Select): The voice of each channel in the multi can be sent from any one of the individual outputs 1–8.
- 10: Assign (Assign Mode Select): The simultaneous note production capability of the TG77 can be allocated among the voices of the multi automatically (DVA) or statically (SVA).
- 15: Initlz (Initialize Multi): The multi data being edited can be initialized to a set of standard values.
- 16: Recall (Recall Multi): The previously edited Multi data can be recalled for additional editing.

## 1. Voice select

JUMP #401

**Summary:** A multi consists of sixteen voices which are controlled by MIDI channels 1–16. A different voice can be selected for each of the sixteen channels in the multi.

**Procedure:**

- From: multi job directory (JUMP #400)
- Select: job 01:Voice (JUMP #401)
- Specify: the voice for each channel of the multi

```

VOICE SELECT                                     401
MULTI • I-03 NewMulti
Selected Voice • P1-A16(16) AP:Grand
01: BA:Wood 05: [off] 09: [off] 13: [off]
02: [off] 06: [off] 10: [off] 14: [off]
03: WN:Alto 07: [off] 11: [off] 15: [off]
04: [off] 08: [off] 12: [off] 16: DR:Grou
On Off Norm Mon Mode Dir Edit
  ①  ②  ③  ④  ⑤  ⑥  ⑦  ⑧  ⑨  ⑩  ⑪  ⑫  ⑬  ⑭  ⑮  ⑯  ⑰
  
```

- ① This displays the number and name of the multi you are editing.
- ② This displays the number and name of the voice where the cursor is located.

- ③ Move the cursor in this area and select a voice for each of the sixteen channels in the multi. This area displays only the first seven characters of the selected voice name, but the voice number and name are fully displayed in ②. Each channel of the multi can use any voice from internal, card, or preset memories, or can be set to an “off” voice. See *Off Voice* below for details.

A multi in card memory can use only card or preset voices. A multi in internal memory can use only internal or preset voices.

If a selected voice contains an AWM element which uses card waveform data, and if the wrong card is inserted into the WAVEFORM slot, an X mark will be displayed instead of the number 1–16, and an incorrect wave will sound. (Each AWM waveform card has a unique ID number which is stored as part of the data for an AWM element.)



- ④ F1 (On), F2 (Off): To turn off the voice selected by the cursor, press F1 (Off). To turn the voice on again, press F2 (On). For details, see *Off Voice*, below.
- ⑤ F3 (Norm), F4 (Mon): When in Multi edit mode, you have a choice of MIDI input modes; Normal or Monitor.

When normal mode is selected, each incoming channel of MIDI data will play only the voice of the corresponding channel.

When monitor mode is selected, all incoming channels of MIDI data will play the voice where the cursor is located in this Voice Select display. This is useful when you wish to check the voices of a multi without changing the transmit channel of your keyboard. Monitor mode remains effective when editing other multi parameters. If monitor mode has been turned on, you will be reminded of this in other multi edit displays. The top line of the display will show (for example) "<Mon 4Ch>", indicating that all incoming MIDI messages will play the voice selected for channel 4 of the multi.

- ⑥ To edit the voice selected by the cursor, press F8 (Edit). You will enter voice edit mode. Details are the same as explained in *Voice edit mode*, but when you press EXIT to exit voice edit mode you will return to this *Multi edit 1. Voice select* job. However you will not be able to edit effect

settings of the voice, and depending on the Voice static Pan setting of the multi, modifying the output select settings or dynamic pan settings of the voice may have no effect.

You can use this function to edit one of the voices in a multi *while that multi is being played from your external sequencer*. This capability is very useful, since it allows you to edit a voice while it is being played in a musical context with other instruments.

- ⑦ To check the voice mode of each voice in the multi, press F6 (Mode).
- ⑧ To see a directory listing of the voices in memory, press F7 (Dir) and use MEMORY and BANK.

**Off Voice:** Each channel of the multi can use any voice from internal, card, or preset memories, or can be turned "off". When turned off, the multi will not play a voice in response to data on that channel.

If you set the output level of an unwanted channel of the multi to 0 (see *Multi edit 2. Voice volume*) it will not be heard, but will still use the TG77's tone generator whenever notes on that MIDI channel are received, and will therefore reduce the simultaneous notes available for the other voices. This is why you should turn unneeded channels of the multi "off".

## 2. Voice volume

JUMP #402

**Summary:** Set the volume of the voice played by each channel of the multi.

**Procedure:**

- From: multi job directory (JUMP #400)
- Select: job 02:Volume
- Specify: the volume for each channel
  - for channels 1-8 press (JUMP #402)
  - F1 (1-8)
  - for channels 9-16 press (JUMP #403)
  - F2 (9-16)

- ① Selected Voice: This displays the number and name of the voice played by the multi channel where the cursor is located.
- ② Voice Volume (0...127): Set the volume for each voice played by the sixteen channels of the multi. The volume for each voice is displayed as a vertical bar graph.
- ③ Holding SHIFT and pressing F1-F8 will move the cursor to voices 1-8 or to voices 9-16, depending on whether F1 or F2 has been pressed.

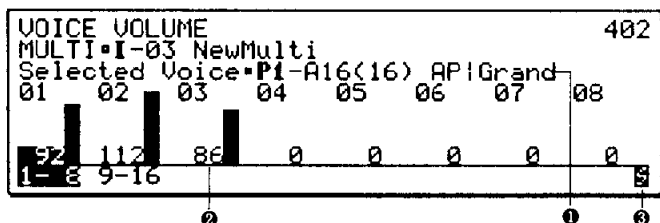

### 3. Voice tuning

JUMP #404

**Summary:** Adjust the fine tuning of the voice played by each channel of the multi.

**Procedure:**

- From: multi job directory (JUMP #400)
- Select: job 03:Tuning
- Specify: the tuning for each channel
  - for channels 1-8 press (JUMP #404)
  - F1 (1-8)
  - for channels 9-16 press (JUMP #405)
  - F2 (9-16)

- ② Voice Tuning (-63...+63 in steps of 1.171875 cents): Set the tuning for each voice played by the sixteen channels of the multi. The tuning for each voice is displayed as a horizontal bar graph.
- ③ Holding SHIFT and pressing F1-F8 will move the cursor to voices 1-8 or to voices 9-16, depending on whether F1 or F2 has been pressed.

*Note: The actual pitch at which a voice will sound is affected by many other factors; System utility settings 1. Master tuning, Voice common data 2. Element detune, 3. Element note shift, 11. Micro tuning, AFM element data 2. AFM oscillator, 7. AFM pitch EG, and AWM element data 1. AWM waveform set, 6. AWM pitch EG.*

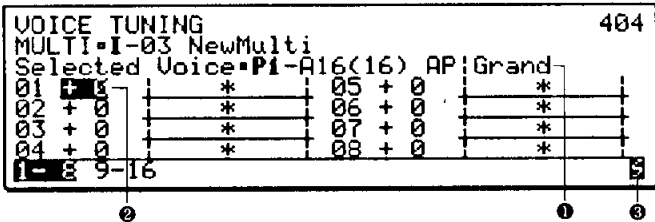

- ① Selected Voice: This displays the number and name of the voice played by the multi channel where the cursor is located.

### 4. Voice note shift

JUMP #406

**Summary:** Adjust the note shift (transposition) of the voice played by each channel of the multi.

**Procedure:**

- From: multi job directory (JUMP #400)
- Select: job 04:Shift
- Specify: the note shift for each channel
  - for channels 1-8 press (JUMP #406)
  - F1 (1-8)
  - for channels 9-16 press (JUMP #407)
  - F2 (9-16)

- ① Selected Voice: This displays the number and name of the voice played by the multi channel where the cursor is located.
- ② Voice Note Shift (-64...+63 in half steps): Set the note shift (transposition) for each voice played by the sixteen channels of the multi. The note shift setting for each voice is displayed as a horizontal bar graph.
- ③ Holding SHIFT and pressing F1-F8 will move the cursor to voices 1-8 or to voices 9-16, depending on whether F1 or F2 has been pressed.

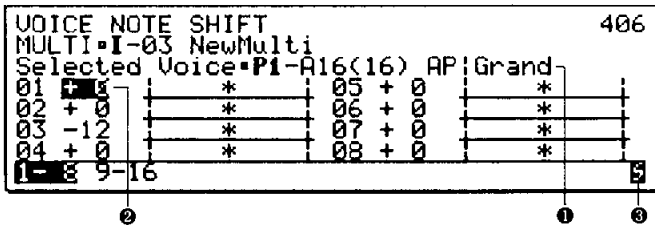

## 5. Voice static pan

JUMP #408

**Summary:** Specify the stereo position for the voice played by each channel of the multi.

**Procedure:**

From: multi job directory (JUMP #400)

Select: job 05:St-Pan

Specify: the static pan position for each channel

for channels 1-8 press (JUMP #408)

F1 (1-8)

for channels 9-16 press (JUMP #409)

F2 (9-16)

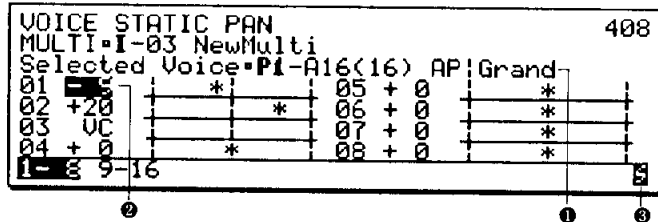

- ① Selected Voice: This displays the number and name of the voice played by the multi channel where the cursor is located.

- ② Voice Static Pan (VC or -31...+31 = left...right): Set the static pan position for each voice played by the sixteen channels of the multi. The static pan setting for each voice is displayed as a horizontal bar graph.

It is also possible to select "VC", when the voice will use its own pan data. If "VC" is not selected, the pan data of the voice will be ignored and the static pan setting you specify here will be used. If "VC" is not selected for a drum voice, all the drum sounds will be panned to the same pan position -31...+31 you specify here.

- ③ Holding SHIFT and pressing F1-F8 will move the cursor to voices 1-8 or to voices 9-16, depending on whether F1 or F2 has been pressed.

## 6. Voice output group select

JUMP #410

**Summary:** Each voice can be sent from either or both output groups, to determine how the voice will be processed through the effect units.

**Procedure:**

From: multi job directory (JUMP #400)

Select: job 06:OutSel

Specify: the output group for each channel

for channels 1-8 press (JUMP #410)

F1 (1-8)

for channels 9-16 press (JUMP #411)

F2 (9-16)

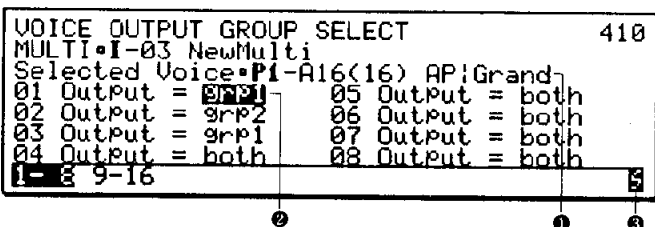

- ① Selected Voice: This displays the number and name of the voice played by the multi channel where the cursor is located.

- ② Output (off, grp1, grp2, both): Each voice played by a multi is independently panned according to the setting of 5. *Voice static pan*, and this stereo output of each voice is sent to the DSP effects unit via Output Group 1, 2, or both. The output group setting of the voice itself will be ignored unless this is set "off".

Multi edit settings cannot determine the output group for a multi channel that plays a drum voice, and the cursor cannot be moved to these voices. The display will show "Output = drum", and the drum voice data will determine which output group is used by each drum sound. Refer to *Drum set data, 2. Wave data set* (JUMP #274).

- ③ Holding SHIFT and pressing F1-F8 will move the cursor to voices 1-8 or to voices 9-16, depending on whether F1 or F2 has been pressed.

## MULTI EDIT MODE

**Output:** The selected Output Group(s) will determine how the voice is processed by the effect units as you specify in 7. *Effect set*. If the output group is "Off" the voice will not be processed through the effect units. The unprocessed sound of the voice will be heard if the Stereo Mix of the effect unit is turned on.

Channel	Voice	Static Pan	Output Select	
1	P1 - B1 BR;BigBand	-15	both	Group1 L → R →
2	P1 - D13 BA;Woodbas	VOICE	1	
3	P1 - A16 AP;Grand	+31	2	Group2 L → R →
...	...	...	...	
16	P1 - C11 WN;Clarino	+04	2	

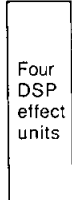

## 7. Effect set

JUMP #412

**Summary:** The four effects in the effect unit can be arranged in various ways to add modulation and reverb to the sound.

**Procedure:**

- From: multi job directory (JUMP #400)
- Select: job 07:Effect (JUMP #412)

```

EFFECT SET 412
MULTI-I-03 NewMulti
01:Effect Mode Select 01
02:Modulation Effect 1 Set
03:Modulation Effect 2 Set
04:Reverb Effect 1 Set
05:Reverb Effect 2 Set
01 02 03 04 05
    
```

- 1 Move the cursor in this area to select a job.
  - 01: Effect Mode Select: Specify how the four effect units will be connected. (JUMP #413)
  - 02: Modulation Effect 1 Set: Select an effect type and set parameters for modulation effect 1. (JUMP #414, #415)
  - 03: Modulation Effect 2 Set: Select an effect type and set parameters for modulation effect 2. (JUMP #416, #417)

04: Reverb Effect 1 Set: Select an effect type and set parameters for reverb effect 1. (JUMP #418, #419)

05: Reverb Effect 2 Set: Select an effect type and set parameters for reverb effect 2. (JUMP #420, #421)

2 Pressing F1-F5 will select the corresponding job.

The sixteen voices played by a multi are processed through the effect units as determined by the output group selected for each voice. Refer to the previous section, 6. *Voice output group select*.

Job 1.Effect Mode Select determines how the two input groups are routed through the four effect units, and jobs 2-5 determine how each effect unit will process the sound.

Effect settings in multi mode are exactly the same as explained in voice mode. For details, refer to *Voice common data 10.1, 10.2, 10.4*.

## 8. Multi name

JUMP #422

**Summary:** The multi being edited can be given a twenty-character name. In multi play mode, this multi name will be displayed in large characters.

**Procedure:**

- From: multi job directory (JUMP #400)
- Select: job 08:Name (JUMP #422)
- Specify: the name for the multi

```

MULTI NAME 422
MULTI-I-03
      [NewMulti]
Clr  Uppr  Lowr
    
```

- 1 Enter a twenty-character name for the multi.

- ② To clear the currently entered name press F1 (Clr). To switch to upper-case characters press F2 (Uppr). To switch to lower case characters press F3 (Lowr).

**Remarks:** Methods of entering character data are explained in *Introducing the TG77, How to use the numeric key pad*, on page 30.

## 9. Voice individual output select

JUMP #423

**Procedure:** Specify the individual output used by the voice played by each channel of the multi.

From: multi job directory (JUMP #400)

Select: job 09:IndOut

Specify: an individual output 1-8 for each voice for channels 1-8 press (JUMP #423) F1 (1-8)  
for channels 9-16 press (JUMP #424) F2 (9-16)

```

VOICE IND OUTPUT SELECT                                423
MULTI=I-03 NewMulti
Selected Voice=P1-A16(16) AP!Grand
01 Ind.Out = 01  05 Ind.Out = off
02 Ind.Out = 1   06 Ind.Out = off
03 Ind.Out = off 07 Ind.Out = off
04 Ind.Out = off 08 Ind.Out = off
1-8 9-16
  
```

- ① Selected Voice: This displays the number and name of the voice played by the multi channel where the cursor is located.
- ② Individual Output (off, 1-8): Specify the individual output for the voice played by each channel. This setting has no effect on the multi edit parameter 6. *Voice output group select*. Two or more channels of the multi may use the same individual output port if desired.
- ③ Holding SHIFT and pressing F1-F8 will move the cursor to voices 1-8 or to voices 9-16, depending on whether F1 or F2 has been pressed.

## 10. Assign mode select

JUMP #425

**Procedure:** Specify the way in which the simultaneous note production capability of the TG77 is assigned to the voices of the multi.

From: multi job directory (JUMP #400)

Select: job 10:Assign (JUMP #425)

Select: the assign mode (Dynamic or Static)

```

ASSIGN MODE SELECT                                425
MULTI=I-03 NewMulti

Assign Mode = Dynamic (DYNAMIC)
  
```

- ① Assign Mode (Dynamic, Static): This determines the voice assign mode of the entire multi.

The TG77 contains two tone generator circuits; an AFM tone generator capable of producing up to 16 simultaneous notes of AFM sound, and an AWM tone generator capable of producing up to 16 simul-

taneous notes of digitally sampled sound. Especially when you play complex music using two-element or four-element voices, the TG77 may run out of available sound producing circuitry, and must turn off an older note before starting to produce a newly requested note. The Assign Mode parameters allow you to specify how such situations are handled.

**Dynamic Voice Allocation (DVA):** When DVA is selected, the oldest sounding note (of any channel) of the multi will be turned off to make room for any newly requested note (of any channel) which would exceed the TG77's simultaneous note capacity. DVA has the advantage of allowing you to fully use the simultaneous note generation capabilities of the TG77. However, the disadvantage is that the oldest note will be cut off regardless of whether it is musically important, such as a string sound held over several measures.

## MULTI EDIT MODE

**Static Voice Allocation (SVA):** When SVA is selected, you can specify a fixed number of notes to be allocated to each channel. When SVA mode is used, the response to a note-on message may be slightly faster, since the TG77 needs to perform fewer calculations.

After selecting SVA, press F8 (Edit) to make SVA settings. You have two ways of making SVA settings. Refer to the following section, *10.0 SVA edit*.

## 10.0 SVA edit

JUMP #426

**Procedure:** Specify the way in which the simultaneous note production capability of the TG77 is assigned to the voices of the multi.

From: multi edit job 10.Assign (JUMP #425)

When: assign mode is SVA

Press: F8 (Edit) (JUMP #426)

Press: F3 to set SVA independently for AFM and AWM elements (JUMP #426)

Press: F4 to set SVA by total number of notes (JUMP #428)

When making SVA settings using either method, it may be helpful to press F8 (Mode) to see how many AFM and AWM elements are being used for each note of each voice.

**By element:** Press F3 (Elem) to set SVA independently for AFM and AWM elements. This allows you to make most efficient use of the TG77.

SVA EDIT										426
MULTI01-03 NewMulti										
Selected Voice=P2-C14(46) CH:Chamber										
	01	02	03	04	05	06	07	08	Free	
AFM Max	0	0	0	0	0	0	0	0	0	16
AWM Max	0	4	0	0	0	0	0	0	0	12
Note	0	2	0	0	0	0	0	0	0	
1-8 9-16 Elem Note										Mode

- 1 AFM Max: The maximum number of AFM elements that can be used simultaneously by this voice. The total for channels 1-16 of this row cannot exceed 16.
- 2 AWM Max: The maximum number of AWM elements that can be used simultaneously by this voice. The total for channels 1-16 of this row cannot exceed 16.
- 3 Free: The number of unassigned AFM and AWM elements is displayed here.
- 4 Note: This area displays the resulting number of notes that can be produced simultaneously by each channel of the multi. This will depend on

the number of AFM and AWM elements used by the voice selected for each channel of the multi.

- 5 Press F1 (1-8) to make settings for channels 1-8. Press F2 (9-16) to make settings for channels 9-16.

- 6 Press F8 (Mode) to view the voice mode of the sixteen voices used in the multi. Press EXIT to return to the SVA Edit display.

**AFM Max, AWM Max, Note:** Setting the number of SVA notes independently for AWM and AFM elements allows you to take maximum advantage of the TG77's tone generating circuitry when all-AFM or all-AWM voices are used in the multi.

For example in the above LCD, the CH:Chamber voice used in channel 2 of the multi "3.NewMulti" is a 2AWM element voice; i.e., each note uses two AWM notes. For this voice, setting AWM Max of multi channel 2 to 4 would allow that voice to produce up to two simultaneous notes. The AFM Max setting for the voice can be set at 0, for use by a different voice which uses only AFM elements.

- By note:** Press F4 (Note) to set SVA by total note numbers. This is easier, but may be slightly wasteful if the multi uses all-AFM or all-AWM voices.

SVA EDIT										428
MULTI01-03 NewMulti										
Selected Voice=P2-C15(47) CH:Spirit										
Voice Mode : 1AFM & 1AWM										
	01	02	03	04	05	06	07	08		
Note	4	6	0	0	0	0	0	0	0	
1-8 9-16 Elem Note										Mode

- 1 Selected Voice: This displays the number and name of the voice selected by the cursor.

- ② Voice Mode: This displays the number and type of elements used in the voice selected by the cursor.
- ③ Note: Specify the number of notes that can be played simultaneously by each channel of the multi. The total number of elements used by all voices cannot exceed 16 AFM or 16 AWM elements.
- ④ Press F1 (1-8) to make settings for channels 1-8. Press F2 (9-16) to make settings for channels 9-16.

- ⑤ Press F8 (Mode) to view the voice mode of the sixteen voices used in the multi. Press EXIT to return to the SVA Edit display.

In the above LCD, channel 2 of this multi uses the CH:Chamber voice, which is 2AWM element voice. If we allow this voice 6 notes, it will use up 12 AWM elements. The 1AFM&1AWM CH!Spirit voice used by channel 1 of the multi uses 1 AWM element for each voice, and can be allowed 4 notes, which beings the total of AWM elements to the maximum of 16.

## 15. Initialize multi

**Summary:** The multi data being edited can be initialized to a set of standard values.

**Procedure:**

From: multi job directory (JUMP #400)

Select: job 15:Initz

To execute: the initialize operation press YES.

To quit: without executing press NO or EXIT.

INITIALIZE MULTI

**ARE YOU SURE ?**

(Yes or No)

This function sets all multi data values to the minimum or simplest possible setting. When you are creating a new multi it is often convenient to start with the initial settings.

If you are sure you want to initialize the multi data, press YES and the data of the multi being edited will be set to the values shown below. If you decide not to initialize, press NO.

### Initialized settings for Multi data

01 Voice select

Preset 1 A01(01) GrandPiano (all channels)

02 Voice volume

Volume = 127 (maximum) (all channels)

03 Voice tuning

Tuning =  $\pm 0$  (all channels)

04 Voice note shift

Note Shift =  $\pm 0$  (all channels)

05 Voice static pan

Pan =  $\pm 0$  (= center) (all channels)

06 Voice output group select

Output = both (all channels)

07 Effect set

\*\*\* same as for normal voice \*\*\*

08 Name multi

Name = INIT MULTI VOICE

09 Voice individual output select

off (all channels)

10 Assign mode select

Assign mode = DVA

Max number of elements

AFM = 16, AWM = 16 (channel 1)

AFM = 0, AWM = 0 (channels 2-16)

## 16. Recall multi

**Summary:** The previously edited Multi data can be recalled for additional editing.

**Procedure:**

From: multi job directory (JUMP #400)

Select: job 16:Recall

To execute: the recall operation press YES.

To quit: without executing press NO or EXIT.

If after editing a multi you exit multi edit mode without storing, the edited multi data will be lost. In such cases, you can use this function to recall the previously edited multi data into the editing buffer.

If you are sure you want to recall, press YES and the previously edited multi data will be recalled into the editing buffer. If you decide not to recall, press NO.

RECALL MULTI

ARE YOU SURE ?

(Yes or No)



# UTILITY MODE

In utility mode you can make settings that affect the TG77's overall system, make settings for MIDI transmission and reception, transmit bulk data via MIDI, and save or load data on card. You can also play the built-in demo songs.

<b>Contents of this section</b>	<b>page</b>
<b>System utility</b> .....	<b>171</b>
<b>MIDI utility</b> .....	<b>174</b>
<b>Card utility</b> .....	<b>178</b>
<b>Demo utility</b> .....	<b>180</b>

## UTILITY MODE

In Utility mode you can make settings that affect the TG77's overall system, make settings for MIDI transmission and reception, transmit bulk data via MIDI, save or load data on card, or play the built-in demo songs. The functions of utility mode are divided into four job directories; System Utility, MIDI Utility, Card Utility, and Demo Utility. When you press UTILITY the last-selected of these directories will appear. Select a job directory by pressing F1-F4.

### System Utility job directory

```
UTILITY 800
System Utility 01
01:Master Tuning
02:Velocity Set
03:Edit Confirm
04:Greeting Message
Sys MIDI Card Demo
```

- 01:Master Tuning: The overall tuning of the TG77 can be adjusted both in half steps and fine tuning.
- 02:Velocity Set: A velocity curve can be selected to allow the TG77 to respond in different ways to note-on velocity.
- 03:Edit Confirm: The "Are you sure?" message that appears when you store, recall, or initialize data can be turned on/off.
- 04:Greeting Message: Edit the two-line message that is briefly displayed when the TG77 power is turned on.

### MIDI Utility job directory

```
UTILITY 806
MIDI Utility 01
01:Channel Set
02:Program Change
03:Bulk Dump
Sys MIDI Card Demo
```

- 01:Channel Set: The TG77 will receive and transmit MIDI data as determined by the MIDI channels and settings specified here.
- 02:Program Change: MIDI program change messages will be received as specified here.
- 03:Bulk Dump: Various types of TG77 data can be transmitted via MIDI to another TG77 or other device.

### Card Utility job directory

```
UTILITY 812
Card Utility 01
01:Save To Card
02:Load From Card
03:Format Card
Sys MIDI Card Demo
```

- 01:Save To Card: Data can be saved to a RAM card.
- 02:Load From Card: Data can be loaded from a RAM or ROM card.
- 03:Format Card: Before a RAM card can be used it must be formatted to accept TG77 data.

### Demo Utility

```
UTILITY 823
Demo Utility
>>> Press ENTER <<<
Setup Parameters will be exchanged !
Sys MIDI Card Demo
```

The TG77 contains data for ten demo songs in ROM (permanent memory). This data can be loaded, and the ten songs played in succession. You can select a song to begin playing from.

## System utility

JUMP #800

**Summary:** System utility settings affect the entire TG77 system.

**Procedure:**

From: MIDI Utility, Card Utility, or Demo Utility  
(JUMP #806, #812, #823)

Press: F1 (Sys) (JUMP #800)

Select: the desired system utility job and press  
ENTER.

<b>UTILITY</b>	800
System Utility	01
01: Master Tuning	
02: Velocity Set	
03: Edit Confirm	
04: Greeting Message	
Sys MIDI Card Demo	0

- ① Move the cursor in this area to select one of the following jobs and then press ENTER.

- 01: Master Tuning: The overall tuning of the TG77 can be adjusted both in half steps and fine tuning.
- 02: Velocity Set: The TG77 can be set to respond to note-on velocity in various ways.
- 03: Edit Confirm: The “Are you sure?” message that appears when you store, recall, or initialize data can be turned on/off.
- 04: Greeting Message: The two-line message that is briefly displayed when the TG77 power is turned on can be edited.

- ② Holding SHIFT and pressing F1–F4 will select the corresponding System Utility job.

SYSTEM UTILITY

## 1. Master tuning

JUMP #801

**Summary:** The overall tuning of the TG77 can be adjusted both in half steps and fine tuning.

**Procedure:**

From: system utility job directory (JUMP #800)

Select: 01:Master Tuning (JUMP #801)

Specify: the overall tuning in half steps and fine steps

<b>MASTER TUNING</b>	801
Note Shift = + 0	
Fine Tuning = + 0	
Note Fine	

- ① Note Shift (–64...+63): This adjusts the pitch of the entire TG77 in half steps.
- ② Fine Tuning (–64...+63): This adjusts the pitch of the entire TG77 in steps of 1.171875 cents.

**Remarks:** To adjust the pitch of only specific voices, refer to *Voice Common job 2. Element detune* and *3. Note shift*.

**Note Shift:** This note shift setting does not affect drum voices. A drum voice has its own note shift settings, which are set independently for each note. Refer to *Drum set data, 2. Wave data set*, page 148.

SYSTEM UTILITY

## 2. Velocity set

JUMP #802

**Summary:** The TG77 can be set to respond to note-on velocity in various ways.

**Procedure:**

From: system utility job directory (JUMP #800)

Select: 02:Velocity Set (JUMP #802)

Specify: the velocity curve

## UTILITY MODE

```

VELOCITY SET                                802
Velocity Curve = 0 (normal)
    
```

- 1 Velocity Curve (0...7): This determines the way in which the TG77 tone generator will respond to your playing velocity as shown in the following diagrams.

Velocity curves 6 (cross-1) and 7 (cross-2) allow you to crossfade between two elements using key velocity. Set one element to positive key velocity sensitivity and the other to negative key velocity sensitivity. Refer to *AFM element data 5. AFM sensitivity (JUMP #243)* and *AWM element data 4. AWM sensitivity (JUMP #260)*.

0. Normal

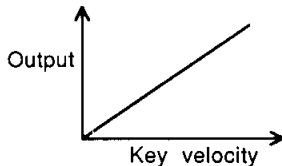

1. Soft - 1

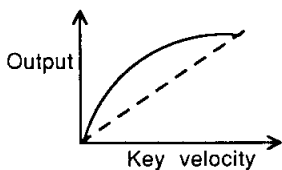

2. Soft - 2

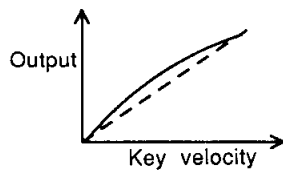

--- is the Normal velocity curve

3. Easy

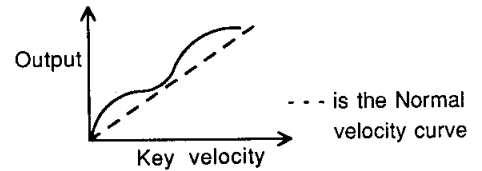

4. Wide

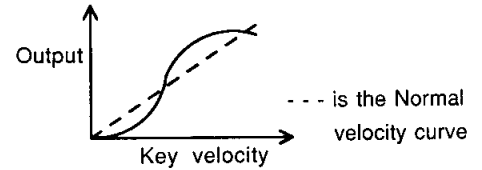

5. Hard

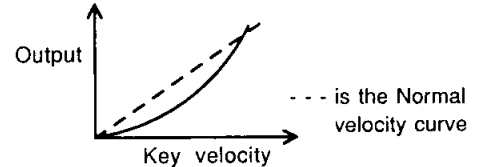

6. Cross - 1

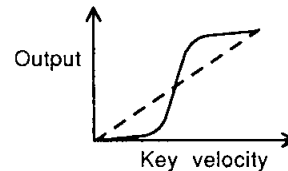

7. Cross - 2

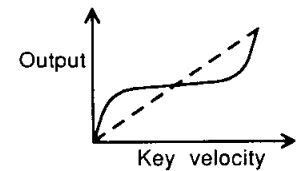

--- is the Normal velocity curve

## SYSTEM UTILITY

### 3. Edit confirm

JUMP #804

**Summary:** The "Are you sure?" message that appears when you store, recall, or initialize data can be turned on/off.

**Procedure:**

- From: system utility job directory (JUMP #800)
- Select: 03:Edit Confirm (JUMP #804)
- Specify: whether or not the confirm message will appear

```

EDIT CONFIRM                                804
Edit Confirm = on
    
```

- 1 Edit Confirm (on, off): When this is on you will be asked "Are you sure?" whenever an operation that erases or replaces data is about to be performed. When this is off the operation will be executed without asking for confirmation.

**Remarks:** Until you are familiar with the TG77 we recommend that you leave this on.

SYSTEM UTILITY

## 4. Greeting message

JUMP #805

**Summary:** Edit the two-line message that is briefly displayed when the TG77 power is turned on.

**Procedure:**

From: system utility job directory (JUMP #800)

Select: 04:Greeting Message (JUMP #805)

Specify: the greeting message

GREETING MESSAGE		805
Line 1	= [ Welcome to ]	
Line 2	= [ RCM synthesis ! ]	
Clr   Uppr <b>Lowr</b>		

- ❶ Enter the two-line x 20 character greeting message.
- ❷ To clear the currently entered message press F1 (Clr). To switch to upper-case characters press F2 (Uppr). To switch to lower-case characters press F3 (Lowr).

**Remarks:** Methods of entering character data are explained in *How to enter data of Introducing the TG77*.

## MIDI utility

JUMP #806

**Summary:** MIDI utility settings determine how MIDI data is transmitted and received.

**Procedure:**

From: System Utility, Card Utility, or Demo Utility (JUMP #800, #812, #823)

Press: F2 (MIDI) (JUMP #806)

Select: the desired MIDI utility job and press ENTER.

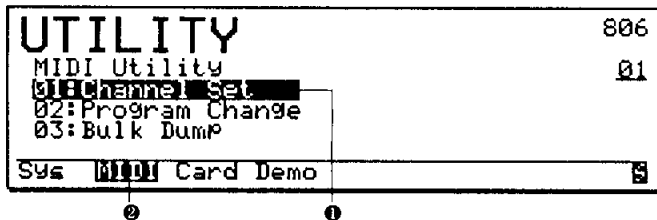

- ① Move the cursor in this area to select one of the following jobs and then press ENTER.
  - 01: Channel Set: The TG77 will receive and transmit MIDI data as determined by the MIDI channels and settings specified here.
  - 02: Program Change: MIDI program change messages will be received and transmitted as specified here.
  - 03: Bulk Dump: Various types of TG77 data can be transmitted via MIDI to another TG77 or other device.
- ② Holding SHIFT and pressing F1–F3 will select the corresponding MIDI Utility job.

MIDI UTILITY

## 1. Channel set

JUMP #807

**Summary:** The TG77 will receive and transmit MIDI data as determined by the MIDI channels and settings specified here.

**Procedure:**

From: MIDI utility job directory (JUMP #806)

Select: 01:Channel Set (JUMP #807)

Specify: MIDI transmit and receive channels and settings

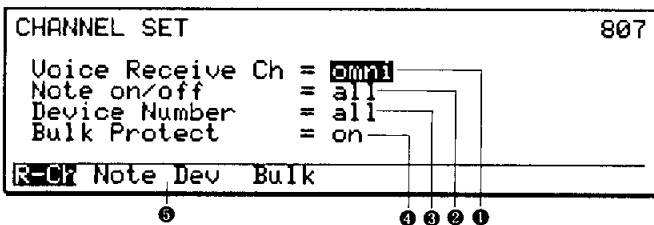

- ① Voice Receive Channel (1...16, omni): This determines the channel on which the TG77 can be played when in voice play mode. When "omni" is selected the TG77 will respond to any channel. In multi play mode, program changes received on this channel will select multis.
- ② Note on/off (all, odd, even): When set to "all" the TG77 will produce sound in response to all notes received at MIDI IN. When set to "odd" or "even", the TG77 will respond only to odd or even notes.

- ③ Device Number (off, 1...16, all): This determines the channel on which the TG77 will receive and transmit MIDI system exclusive messages such as parameter changes and bulk data. When off is selected system exclusive messages will not be received. When "all" is selected system exclusive messages will be received on any channel 1...16.
- ④ Bulk Protect (off, on): The TG77 is able to receive system exclusive bulk data at any time, and the newly received data will replace the data in memory. By setting bulk protect on you can prevent unexpectedly arriving bulk data from overwriting important data.
- ⑤ Pressing F1–F4 will move the cursor to the corresponding item in the display.

**Note on/off:** This setting can be used to increase the number of simultaneous notes. Each TG77 is able to produce up to 16 notes of AFM sound and 16 notes of AWM sound at once. By sending the same MIDI data to two TG77s and setting one to note "odd" and the other to note "even", you can double the number of simultaneous notes that can be produced.

## 2. Program change

**Summary:** MIDI program change messages will be received as specified here.

**Procedure:**

From: MIDI utility job directory (JUMP #806)

Select: 02:Program Change (JUMP #808)

Specify: how program changes will be received

PROGRAM CHANGE	808
Program Change = table	
	Edit

- ① **Program Change (off, normal, direct, table):** This determines what the TG77 does when a program change message is received at MIDI IN.

**Program Change = off:** Incoming program change messages will be ignored.

**Program Change = normal:** When in voice mode, incoming program changes 0–63 will select voices 1–64. Program changes 64–127 will be ignored.

When in multi mode, incoming program changes 0–63 will select voices 1–64 for the corresponding channel of the multi. Program changes 64–79 on the voice receive channel will select multis 1–16. Program changes 80–127 will be ignored.

**Program change = direct:** This allows any voice or multi memory to be selected using program changes. Program changes 0–116 will be received just as in “normal”.

Incoming program changes 117–124 will select a voice memory, and must be immediately followed by a program change 0–63 to select the voice number. Incoming program changes 125–127 will select a multi memory, and must be immediately followed by a program change 64–79 to select the multi number.

Incoming program changes 119 and 120 are not distinguished, since a internal multi is not allowed to use card voices, nor vice versa.

No.	Mode	Type	Memory
117	Voice mode	Voice	Preset 2
118	Multi mode	Voice	Preset 2
119	Multi mode	Voice	Internal
120	Multi mode	Voice	Card
121	Multi mode	Voice	Preset 1
122	Voice mode	Voice	Internal
123	Voice mode	Voice	Card
124	Voice mode	Voice	Preset 1
125	Multi mode	Multi	Internal
126	Multi mode	Multi	Card
127	Multi mode	Multi	Preset

**Program change = table:** Each incoming program change 1–128 will select the voice or multi you specify in the Program Change Table. To edit the program change table, press F8 (Edit) and refer to the following section 2.0 *Program change table edit* for details.

## 2.0 Program change table edit

**Summary:** When the MIDI utility parameter 2. Program Change is set to Table, each incoming program change 1–128 will select the voice or multi specified by the table.

**Procedure:**

From: MIDI utility job 2.Program (JUMP #808)  
Change

Press: F8 (Edit) (JUMP #820)

Specify: a voice or multi for each incoming program change 1–128

PC#	Mode	Mem	Pgm	Name
001	Voice	P1	1	SP:Cosmo
002	Voice	P1	2	SP:Metroid
003	Voice	P1	3	SP:Diamond
004	Voice	P1	4	SP:SprPad
▼x5				Init Voic Mult

- ❶ PC#: This indicates the number of the incoming MIDI program change message.
- ❷ Mode (Voice, Multi, Ind.V): You can specify whether the incoming program change will select a voice, a multi, or a voice for an individual channel of a multi.  
Voice: The TG77 will enter voice play mode and will select the voice specified in ❸ Mem and ❹ Pgm.  
Multi: The TG77 will enter multi play mode and will select the multi specified in ❸ Mem and ❹ Pgm.  
Ind.V: If the TG77 is in voice play mode it will remain in voice play mode and will select the voice specified in ❸ Mem and ❹ Pgm. If the TG77 is in multi play mode it will remain in multi mode and will select the voice specified in ❸ Mem and ❹ Pgm for the channel of the multi which matches the MIDI channel of the incoming program change message.

- ❸ Mem (voice I/C/P1/P2, multi P/C/I): Specify the memory of the voice (I/C/P1/P2) or multi (P/C/I).
- ❹ Pgm (voice 1–64, multi 1–16): Specify the number of the voice (1–64) or multi (1–16) to be selected.
- ❺ Name: The first ten characters of the selected voice or multi name are displayed here.
- ❻ F1–F4 (Δ, ▽, Δ x 5, ▽ x 5): Press F1 or F2 to move through the program change table in steps of four lines. Press F3 or F4 to move through the program table in steps of five screens (twenty lines).
- ❼ F6 (Init): To restore the Program Change Table to the initial settings where program changes 1–128 select preset voices P1-A01...P2-D16, press F6. You will be asked "Are you sure?". If you are sure you want to initialize the program change table, press YES. The lower line of the LCD will show "Completed".
- ❽ F7 (Voic): Press F7 to view a list of the sixteen voices in the selected bank. Only the first seven characters of the voice names will be displayed. You can press MEMORY or BANK/SELECT to view other voice banks. This function is provided as a convenience when editing the Program Change Table.
- ❾ F8 (Mult): Press F8 to view a list of the sixteen multis in the selected memory. Only the first seven characters of the multi names will be displayed. You can press MEMORY to view other multi memories. This function is provided as a convenience when editing the Program Change Table.



### 3. Bulk dump

**Summary:** Various types of TG77 data can be transmitted via MIDI to another TG77 or other device.

**Procedure:**

- From: MIDI utility job (JUMP #806)  
directory
- Select: 03: Bulk Dump (JUMP #809)
- Specify: the type of data to be transmitted
- To execute: data transmission press F8 (Go).
- To quit: without executing press EXIT.

BULK DUMP		809
		<u>01</u>
01: Voice & Multi	05: 64 Voice	
02: Setup	06: 16 Multi	
03: Dynamic Pan	07: 1 Voice	
04: Micro Tuning	08: 1 Multi	
		Go

- ① Move the cursor in the area to select the type of data you wish to transmit. Then press F8 (Go).
- 01: Voice & Multi: All internal voice, multi, pan, and micro tuning data
  - 02: Setup: System setup data
  - 03: Dynamic Pan: All internal pan data
  - 04: MicroTuning: All internal micro tuning data
  - 05: 64 Voice: All internal voices
  - 06: 16 Multi: All internal mults
  - 07: 1 Voice: A single specified voice
  - 08: 1 Multi: A single specified multi

**Go:** When you press F8 (Go) transmission will begin and the bottom line of the LCD will display "Now transmitting !" When transmission ends the bottom line will display "Complete !"

**1 Voice:** If you select 07:1 Voice and press F8 (Dir) a directory of the sixteen voices in the currently selected bank will appear. Select a bank A–D, and select a voice 1–16. Then press F8 (Go) and the data of the selected voice will be transmitted. Only internal voices can be dumped.

**1 Multi:** If you select 08:1 Multi and press F8 (Dir) a directory of the sixteen mults in the internal memory will appear. Select a multi 1–16. Then press F8 (Go) and the data of the selected multi will be transmitted. Only internal mults can be dumped.

**Remarks:** For the data to be received by another TG77, the device number settings of the two units must match.

Data transmitted by 07:1 Voice or 08:1 Multi will be received into the editing buffer of the receiving device. If you select another memory before storing it into a memory, the newly received data will be lost.

## Card utility

JUMP #812

**Summary:** Card utility jobs allow you to transfer data to and from a card, and to format a card to accept TG77 data.

**Procedure:**

From: System Utility, MIDI Utility, or Demo Utility (JUMP #800, #806, #823)

Press: F3 (Card) (JUMP #812)

Select: the desired card utility job and press ENTER.

- ① Move the cursor in this area to select one of the following jobs and then press ENTER.
  - 01: Save To Card: Data can be saved to a RAM card.
  - 02: Load From Card: Data can be loaded from a RAM or ROM card.
  - 03: Format Card: Before you use a new RAM card, you must use this operation to format it so that the card can be used by the TG77.
- ② Holding SHIFT and pressing F1–F3 will select the corresponding Card Utility job.

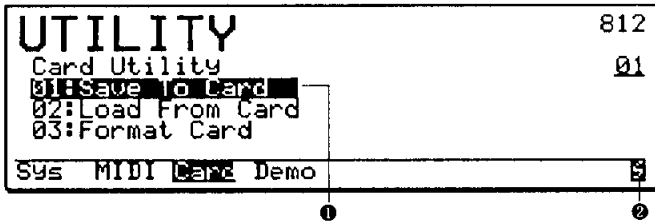

### CARD UTILITY

## 1. Save to card

JUMP #813

**Summary:** Data can be saved to a RAM card.

**Procedure:**

From: card utility job directory (JUMP #812)

Select: 01: Save To Card (JUMP #813)

To execute: the operation press F8 (Go).

To quit: without executing press EXIT.

Press F8 (Go) to save the data to card. The display will ask "Are you sure?" so if you are sure you want to save the data press YES.

If the card inserted in the DATA card slot has not been formatted for the TG77 the LCD will show "Warning: Format Error !" Press EXIT to exit from the error message.

This function saves the following data to RAM card.

- Setup data (system data, pan data, micro tuning data, program change table data)
- Internal voices 1–64
- Internal multis 1–16

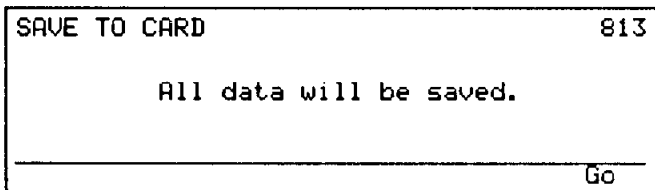

This job saves all data to a RAM card inserted in the DATA card slot. Before a newly purchased RAM card can be used by the TG77 it must be formatted using the 3. *Format card* function explained later in this section.

CARD UTILITY

## 2. Load from card

JUMP #814

**Summary:** Data can be loaded from a RAM or ROM card.

**Procedure:**

From: card utility job directory (JUMP #812)

Select: 02:Load From Card (JUMP #814)

Specify: the type of data to be loaded.

To execute: the load operation press F8 (Go).

To quit: without executing press EXIT.

LOAD FROM CARD	814
Data = <b>all</b>	
_____	
	Go

- ① **Data Type** (all, voice & multi (pan, mct), setup): You can load all or part of the data from card. When "all" is selected all the data will be loaded. When "voice&multi (pan, mct)" is selected multi, voice, pan, and microtuning data will be loaded. When "setup" is selected the system data will be loaded.

This function loads the specified type of voice & multi data from a RAM or ROM card inserted in the DATA card slot. After selecting the data type to load, press F8 (Go) to load the data from card. The display will ask "Are you sure?" so if you are sure you want to load the data press YES.

If the card inserted in the DATA card slot has not been formatted for the TG77 the LCD will show "Warning: Format Error !" Press EXIT to exit from the error message.

CARD UTILITY

## 3. Format card

JUMP #815

**Summary:** Before you use a new RAM card, you must format it so that the card can be used by the TG77.

**Procedure:**

From: card utility job directory (JUMP #812)

Select: 03:Card Format (JUMP #815)

To execute: the operation press F8 (Go).

To quit: without executing press EXIT.

FORMAT CARD	815
Format = Unformatted	
Card data will be erased !	
_____	
	Go

This function prepares a MCD64 RAM card (sold separately) for use by the TG77. If there is no card inserted into the DATA card slot, the display will show "Format = No Card !".

Insert the card into the DATA card slot and press F8 (Go). The display will ask "Are you sure?" so if you are sure you want to format the card press YES.

If the card is a type that cannot be used by the TG77 or if it is faulty the LCD will show an error message. Press EXIT to exit from the error message.

## Demo utility

JUMP #823

**Summary:** This function allows you to load and play the ROM demo songs. These songs are stored in ROM (permanent memory), and cannot be erased or modified.

**Warning:** Loading the demo song data will temporarily override the setup parameters (the Utility mode settings for master tuning, velocity curve, etc.) and the EF.BYPASS switch. These settings will be restored when you exit demo mode.

**Procedure:**

From: System Utility, MIDI Utility, or Card  
 Utility (JUMP #800, #806, #812)  
 Press: F4 (Demo) (JUMP #823)

```

UTILITY                               823
Demo Utility

  >>>      Press ENTER      <<<
  Setup parameters will be exchanged !

SYS  MIDI Card Dem
  
```

Press: ENTER

Select: the song from which to begin playing

Press: F8 (Play) to begin playing

Press: F8 (Stop) to stop playing

Use the cursor keys to select a song from which to begin.

To start the demo songs press F8 (Play). All demo songs will be played in continuous rotation, starting from the song you selected.

If the EF BYPASS button has been pressed, effect bypass will be turned off when the demo data is loaded.

While the demo is playing you can press one of the following keys.

- F1 (Ch): A VU meter-style graphic indicates when each channel is sounding.
- F2 (Note): A VU meter-style graphic indicates the notes played.
- F3 (Kbd): Both keyboard and VU-meter graphics will be displayed.
- F4 (Name): The names of the voices in the multi will be displayed.
- F5 (Time): The display will indicate the elapsed time since the beginning of the currently playing song, and the elapsed time since the play button was pressed.
- F6 (Auto): The above graphics will automatically alternate approximately every five seconds.
- F8 (Stop): Stop the demo.



**APPENDIX**



# APPENDIX

This section contains various supplementary information that may be useful to advanced users or programmers.

<b>Contents of this section</b>	<b>page</b>
<b>Explanation of the preset voices .....</b>	<b>184</b>
<b>Using RCM hybrid synthesis .....</b>	<b>188</b>
<b>Error messages .....</b>	<b>190</b>
<b>Multi data blank chart.....</b>	<b>192</b>
<b>Specifications .....</b>	<b>193</b>
<b>Index.....</b>	<b>194</b>

## Explanation of the preset voices

### Preset 1

- |   |   |
|---|---|
| <p>A-1 <b>SP Cosmo</b> Rich, breathy, analog pad. MW = filter control</p> <p>A-2 <b>SP Metroid</b> Brass type filter envelope</p> <p>A-3 <b>SP Diamond</b> Powerful octave synth with smooth decay. MW = filter control</p> <p>A-4 <b>SP Sqrpad</b> Hollow sounding pad with rising attack pitch EG. MW = filter control</p> <p>A-5 <b>SP Arianne</b> Warm filter sweep with percussive overlay.</p> <p>A-6 <b>SP Sawpad</b> Bright pad with fast attack. MW = vibrato</p> <p>A-7 <b>SP Darkpad</b> Smooth, string-style pad.</p> <p>A-8 <b>SP Mystery</b> Bell and string layer. MW = filter control</p> <p>A-9 <b>SP Padfaze</b> Slow filter swept pad with slow panning.</p> <p>A-10 <b>SP Twilite</b> Delicate synth-vox pad with a crystalline edge.</p> <p>A-11 <b>SP Annapad</b> Deep chorusing and velocity attack filter.</p> <p>A-12 <b>AP Ivory</b> A refined classical piano. MW = filter control</p> <p>A-13 <b>AP CP77</b> Electric grand type piano.</p> <p>A-14 <b>AP Bright</b> Harder, rock piano. MW = filter control</p> <p>A-15 <b>AP Hammer</b> Slightly detuned tack-piano. MW = filter control</p> <p>A-16 <b>AP Grand</b> Full, grand piano. MW = filter control</p><br><p>B-1 <b>BR Plucky</b> Synth brass with fast initial attack and decay. Hold for full effect.</p> <p>B-2 <b>BR BigBand</b> Octave brass with lots of velocity sensitivity.</p> <p>B-3 <b>BR 1980</b> 'Stadium rock' synth brass with pitch swept attack.</p> <p>B-4 <b>BR Trmpets</b> Dual trumpet. MW = filter control, AT = vibrato</p> <p>B-5 <b>BR ModSyn</b> Powerful synth brass with velocity attack filter. MW = filter control, AT = vibrato</p> <p>B-6 <b>BR Ensembl</b> Mellow brass.</p> <p>B-7 <b>BR FrHorn</b> Solo french horn.</p> | <p>B-8 <b>BR Soul</b> A mixture of sampled trumpet and synth brass.</p> <p>B-9 <b>BR.FMBite</b> Sharp, cutting brass. MW = filter control</p> <p>B-10 <b>EP IceRing</b> Tine electric piano with subtle decaying choir background.</p> <p>B-11 <b>EP.Synbord</b> Synth style electric piano with strong velocity sensitivity. MW = filter control</p> <p>B-12 <b>EP.GS77</b> Single element electric piano.</p> <p>B-13 <b>EP Knocker</b> A very dynamic electric piano with lots of key noise. MW = LFO panning</p> <p>B-14 <b>EP Beltine</b> Classic FM type electric piano. MW = tremolo effect</p> <p>B-15 <b>EP Dynomod</b> Dynamic imitative electric piano with bottom end distortion. MW = filter control</p> <p>B-16 <b>EP.Urbane</b> An effect type sound with electric piano overtones.</p><br><p>C-1 <b>ME St.Mick</b> Heavenly choirs. Discover paradise on MW!</p> <p>C-2 <b>ME Blade</b> Evolutionary modulation and filter effect.</p> <p>C-3 <b>ME Forest</b> Sunlight streaming through a leafy glade. Very restful.</p> <p>C-4 <b>ME.Gargoyl</b> Played lightly a pipe organ can be heard. With more velocity unusual things happen.</p> <p>C-5 <b>ME Pickloop</b> A choir, a plucked sound, looped envelopes, flanging, panning: adds up to constant motion.</p> <p>C-6 <b>ME Aquavox</b> A slow choir with bubbling high harmonics slipping round the stereo field.</p> <p>C-7 <b>ME Alps</b> A modulated filter sweep that is effective across its full range.</p> <p>C-8 <b>ME.Cycles</b> Starts as a plucked sound with a gradually slowing modulation effect. Sustained notes produce cyclic effect. MW = filter control</p> <p>C-9 <b>WN Bluharp</b> Blues harmonica with distortion.</p> <p>C-10 <b>WN Tenor</b> Tenor sax with velocity controlled 'cough'. MW = vibrato and tremolo</p> <p>C-11 <b>WN Clarino</b> Woody clarinet that becomes more mellow as MW is introduced.</p> |
|---|---|



- C-12 **WN|AltoSax** Soft, breathy alto sax.  
 C-13 **WN|Moothie** Harmonica for chromatic style playing. Flutter effect on MW.  
 C-14 **WN|Saxion** Sax section. MW = vibrato and tremolo  
 C-15 **WN|Flute** AT modulation flute.  
 C-16 **WN|Ohboy** AT modulation oboe.
- D-1 **ST|Ripper** Bright 'open filter' analog strings. MW = filter control  
 D-2 **ST|Violins** A realistic small violin section.  
 D-3 **ST|Section** Orchestral string section.  
 D-4 **ST|Synstrg** FM type strings. MW = filter control  
 D-5 **ST|Chamber** Strings with a slightly extended decay. MW = fast tremolo  
 D-6 **BA|Frtless** A mixture of FM and sampled fretless bass. AT = vibrato
- D-7 **BA|Starred** Attacking synth bass with a mixture of resonant and non-resonant filtering.  
 D-8 **BA.HardOne** FM bass.  
 D-9 **BA:VC1** Monophonic 'single trigger' type analog bass. MW = filter control  
 D-10 **BA:VC2** High resonance analog bass. MW = filter control  
 D-11 **BA:VC3** Short filter envelope analog bass. MW = filter control  
 D-12 **BA:Rox** Highly touch sensitive hard FM bass.  
 D-13 **BA|Woodbas** Upright bass, MW controls mix between elements.  
 D-14 **BA.Round** Pick bass.  
 D-15 **BA:Erix** Velocity switched slap bass.  
 D-16 **BA.FM Frtls** Single element fretless bass with AT controlled string 'buzz'.

## Preset 2

- A-1 **SC:Newworld** High resonance decaying filter sweep. MW = filter control  
 A-2 **SC.Stratos** Percussive suitar-like synth voice, which evolves into pad on sustained notes.  
 A-3 **SC.Ripples** Digital percussive synth voice which evolves into rippling effect on sustained notes.  
 A-4 **SC.Digitak** Clav style attack slowly moves to a more delicate conclusion. MW = filter control  
 A-5 **SC.Hone** Viciously touch sensitive. Use staccato style of playing for extra 'buzz'.  
 A-6 **SC:Spaces** Powerful bell-like sound with gentle looped chimes when held. MW = LFO panning  
 A-7 **SC|Sybaby** Highly touch sensitive guitar type sound. Hold for 'sighing' effect.  
 A-8 **SC|Icedrop** A 'snowy' sound melting on a warm background.  
 A-9 **SL|Wired** A hammered steel string sound.  
 A-10 **SL.Gnome** Octave lead with portamento.  
 A-11 **SL.SawMono** Sawtooth wave monophonic lead sound. MW = filter control, AT = vibrato  
 A-12 **SL:SqrMono** Detuned square wave monophonic lead. MW = vibrato  
 A-13 **SL.Pro77** Very powerful 'American' lead sound.
- A-14 **SL.Nester** Narrow pulse width lead. Upper harmonic will develop when held. MW = vibrato  
 A-15 **SL:Eazy** Thick resonant lead sound with longer decay and portamento.  
 A-16 **SL:Lips** The sound of someone whistling.
- B-1 **KY|Bosh** Velocity controlled attack synth with additional filter velocity. MW = filter control  
 B-2 **KY|Wahclav** MW filter effect clavinet.  
 B-3 **KY.Wires** Harpsichord-like synth sound.  
 B-4 **KY:Tradclv** Traditional clavinet sound with MW chorusing effect.  
 B-5 **KY.Thumper** Percussive FM synth sound.  
 B-6 **KY|Modclav** MW damped clavinet.  
 B-7 **PL.Sitar** The sound of India.  
 B-8 **PL.Harp** Single element harp.  
 B-9 **PL|Saratog** A 'new age' electric guitar sound.  
 B-10 **PL|Steel** Folk guitar. AT = vibrato  
 B-11 **PL|Twelve** A twelve string acoustic guitar simulation.  
 B-12 **PL|Shonuff** Feedback lead electric guitar.  
 B-13 **PL|MutGtr** Velocity switching between muted and unmuted electric guitar.  
 B-14 **PL.Guitar** A steel strung acoustic guitar useful for solos.

## APPENDIX

- B-15 **PL:Shami** Shamisen. An oriental plucked string instrument.
- B-16 **PL:Koto** Another oriental plucked string instrument.
- C-1 **OR:YC45D** Percussive organ.
- C-2 **OR:Pipes** Church organ with MW 'stop' effect.
- C-3 **OR:Jazzman** Jazz organ with MW leslie effect.
- C-4 **OR.Combo** Sixties electronic organ. MW = filter control
- C-5 **PC:Marimba** Marimba sampled sound.
- C-6 **PC:OzHamer** Percussive loop effect.
- C-7 **PC:Tobago** Realistic steel drum sound.
- C-8 **PC.Vibes** Smooth vibes sound with MW tremolo.
- C-9 **PC:Glass** Glassy sounding bells.
- C-10 **PC:Island** A cross between marimba and steel drums.
- C-11 **PC:GrtWall** Celebrate Chinese New Year with this sound. MW = filter control
- C-12 **CH:Itopia** Smooth, rich choir sound.
- C-13 **CH:GaChoir** Percussive vocal sound making 'ga' noise. MW = filter effect
- C-14 **CH:Chamber** Cathedral choir.
- C-15 **CH:|Spirit** Ethereal, shimmering choir.
- C-16 **CH:ChorMst** A slow sweeping choir in fifths. Try playing triads.
- D-1 **SE\*Goto>1** The Beatles did this once.
- D-2 **SE.Xpander** A never ending ice-cream van.
- D-3 **SE\*Inferno** A long evolutionary sound.
- D-4 **SE\*Them!!!** Will the giant ants take over the earth?
- D-5 **OR\*Gassman** Full sounding organ. MW adds percussion and additional harmonics.
- D-6 **BR\*ZapBras** Powerful synth brass. Using MW while playing makes this very expressive.
- D-7 **BR\*BrasOrc** Orchestral sound with lots of velocity sensitivity. MW = filter control
- D-8 **PL\*Stairwy** Thick guitar-like sound.
- D-9 **ST\*Widestg** Responsive orchestral strings.
- D-10 **ST\*Symbflow** Smooth, clear strings. MW = volume control
- D-11 **ST\*Quartet** String quarted sound. Staccato playing gives string bowing effect.
- D-12 **ST\*Tutti** Tutti orchestra. Lower keys have velocity switch timpani. MW introduces bells.
- D-13 **ME\*Voyager** Choir with sweeping synth background.
- D-14 **ME\*Galaxia** A trip to the stars made more impressive with increased velocity.
- D-15 **DR Both** Power drum kit.
- D-16 **DR Group2** Drum kit designed for use in Multi mode. All voices sent to group 2.

## Preset drum voice key assignments

Drum Set	Preset2-D15 DR Both		Preset2-D16 DR Group2	
Note Num	Waveform Name	No.	Waveform Name	No.
C1	BD2	94	BD2	94
C#1	BD4	96	BD2	94
D1	SD roll	100	BD1	93
D#1	Crash	106	BD1	93
E1	Tom1	102	BD3	95
F1	Tom1	102	BD3	95
F#1	Tom1	102	BD4	96
G1	Tom1	102	BD4	96
G#1	BD3	95	BD1	93
A1	BD1	93	BD1	93
A#1	SD1	97	Tom2	103
B1	Tom2	103	Tom2	103
C2	Tom2	103	Tom2	103
C#2	SD3	99	SD3	99
D2	Tom2	103	Tom2	103
D#2	Rim	101	Rim	101
E2	SD2	98	SD2	98
F2	Tom2	103	Tom2	103
F#2	Claps	108	Claps	108
G2	Cowbell	109	Cowbell	109
G#2	Shaker	111	Shaker	111
A2	HHclosed	104	HHclosed	104
A#2	Tambrn	110	Tambrn	110
B2	HHopen	105	HHopen	105
C3	Crash	106	Crash	106
C#3	Crash	106	Crash	106
D3	Ride	107	Ride	107
D#3	Ride	107	Ride	107
E3	Tom2	103	Ride	107
F3	Tom2	103	Ride	107
F#3	Cowbell	109	Crash	106

Drum Set	Preset2-D15 DR Both		Preset2-D16 DR Group2	
Note Num	Waveform Name	No.	Waveform Name	No.
G3	Cowbell	109	Cowbell	109
G#3	Cowbell	109	StlDrmWv	54
A3	SD2	98	Cowbell	109
A#3	SD2	98	StlDrmWv	54
B3	SD2	98	Tom1	102
C4	SD2	98	Tom1	102
C#4	EG mute	16	SD1	97
D4	EG mute	16	Tom1	102
D#4	EG mute	16	SD1	97
E4	EG mute	16	Tom1	102
F4	EG mute	16	Tom1	102
F#4	EG mute	16	SD3	99
G4	EG mute	16	SD2	98
G#4	EG mute	16	SD3	99
A4	EG mute	16	SD2	98
A#4	EG mute	16	SD2	98
B4	EG mute	16	SD2	98
C5	EG mute	16	AnlgPerc	112
C#5	EG mute	16	AnlgPerc	112
D5	EG mute	16	Tambrn	110
D#5	EG mute	16	Tambrn	110
E5	EG mute	16	HHopen	105
F5	EG mute	16	Crash	106
F#5	EG mute	16	Crash	106
G5	EG mute	16	Crash	106
G#5	EG mute	16	Crash	106
A5	EG mute	16	Crash	106
A#5	EG mute	16	SD roll	100
B5	EG mute	16	SD roll	100
C6	EG mute	16	*Shaker	111

\* This sound is set to a volume of zero for use as a mute for other alternately-assigned sounds.

## Using RCM hybrid synthesis

### Suggestions for using AWM + AFM (Voice modes 9 & 10)

The ability to use an AWM voice as an input to an operator is one of the radical innovations of the TG77. Since the architecture is so flexible it will be a long time before this capability can be fully explored. This section will suggest one possible starting point for experimentation.

1. Select the voice mode

From: Voice edit mode  
 Select: Voice mode (F1) (JUMP #200)  
 Select: Voice Mode 9 (1AFM&1AWM)  
 Press: F2 (Com)

2. Initialize the voice common data

From: Voice edit (JUMP #201)  
 Select: 15:Initialz (Initialize voice)  
 Press: ENTER  
 Press: YES at the "Are you sure?" prompt  
 Press: EXIT at the "Completed !" prompt

3. Initialize the AFM element

From: Voice edit (JUMP #201)  
 Press: F3 (E1) AFM Element (JUMP #230)  
 Select: 15:Initialz (Initialize AFM element)  
 Press: ENTER  
 Press: YES at the "Are you sure?" prompt  
 Press: EXIT at the "Completed !" prompt

4. Initialize the AWM element

From: Voice edit (JUMP #230)  
 Press: F4 (E2) AWM element (JUMP #256)  
 Select: 15:Initialz (Initialize AWM element)  
 Press: ENTER  
 Press: YES at the "Are you sure?" prompt  
 Press: EXIT at the "Completed !" prompt

5. Select an AWM wave

Press: F4 (E2) to edit the (JUMP #256)  
 AWM element  
 Select: 1:WaveSet (JUMP #257)  
 (AWM waveform set)

Press: the -1 +1 buttons or use the slider to select the wave you wish to use.

When you play a note you will notice that all waves will sound with the initialized "organ type" EG, and no velocity or filtering. You will probably want to add final touches later. EG filtering and dynamic information are carried over into the FM operator. However for now we will use only a raw wave in order to explain the mechanics of RCM hybrid voicing.

Before trying to use an AWM wave in an AFM algorithm it is useful to turn off the AWM direct output. This is not necessary for final voicing since many voices use *both* the direct AWM sound and the hybrid AWM/AFM combination. However it is easier to understand the effect of the hybrid system if the direct output of the AWM element is temporarily turned off.

6. To turn off the AWM:

From: Voice Edit (JUMP #201)  
 Select: 7:OutSel (JUMP #208)  
 Press: F2 (E2) to select element 2.  
 Press: -1 three times to turn element output off.  
 Press: EXIT to return to the voice edit job directory

7. Select Algorithm 30 (default in INIT AFM voice)

*Note: Any algorithm will work with hybrid voicing. However we will use the default algorithm 30 in this demonstration, so this step is not necessary.*

8. Set operators 1 and 2 to fixed frequency, zero frequency.

Press: F3 to select the AFM (JUMP #230)  
 job directory  
 Select: 2:Osclltr (JUMP #235)  
 Press: Operator Select button 1 to choose operator 1

Select: Freq Mode and use -1 +1 to change "ratio" to "fixed"  
 Select: Coarse and use -1 +1 to change 1.0 to 0.00  
 Press: Operator select button to choose OP2 and repeat the above operation.  
 Press: EXIT to return to the AFM job directory

9. Introduce the AWM wave into operator 2 of the FM algorithm

From: Voice Edit  
 Press: F3 (E1) to select the (JUMP #246)  
 AFM element for editing  
 Select: 1:Algrthm (JUMP #232)  
 (AFM algorithm)  
 Press: F2 (Extn) This page selects the external inputs to each operator.

Use the cursor keys to position the cursor over the "off" on the AWM line under OP2. Press YES to change the "off" to In1.

Press: EXIT to return to the AFM job directory

10. Raise the output level of operator 2.

From: AFM job directory  
 Select: 4:Output and press (JUMP #242)  
 F2 (All)  
 Move: the cursor to OP2 and use the data slider to gradually raise the level until you hear the AWM wave.

**Important note:** Depending on the harmonic content of the selected wave, the sound may become distorted as you increase the output level of OP2. If it does, exit to the AFM job directory, select 1:Algrthm and press F3 (Inpt) (JUMP #233). Note that under the AWM indicator beneath OP2 there is a number 7. Lower this value to 4 and then return to 4:Output (JUMP #242) and adjust the OP2 output level again. The level set for each operator in the Algorithm Input acts as a multiplier for the value specified in Output. To avoid distorting the sound appearing at Op2, you must set the correct gain values. Of course, distortion can be an interesting effect in its own right. By adjusting the operator output and operator input, a wide range of AWM input levels can be used.

The steps outlined so far may not result in a very interesting sound, but the following points will illustrate some of the possibilities of RCM hybrid synthesis.

- The AFM operator into which the AWM waveform was introduced can be modulated by other operators, or can modulate other operators.
- The same AWM waveform can be introduced into two or more AFM operators, perhaps with each operator set to a different pitch.
- Since the AWM waveform is routed through the filter of the AWM element before being introduced into the AFM operator, its filter settings can be continuously varied, resulting in a realtime filtered waveform which can be modulated by and can modulate other operators (waveforms); i.e., *Realtime Convolution and Modulation* — RCM hybrid synthesis. ("Convolution" refers to proprietary Yamaha digital filtering technology.)

It is beyond the scope of this manual to provide detailed instruction in the use of this new hybrid system although additional programming guides will be forthcoming. The only steps required for using RCM hybrid synthesis are to turn on the AWM in the Inpt page and select voice mode 9 or 10. The rest is up to you. This is simply a very basic guide which you may use as a starting point.

## Error messages

### MIDI

**MIDI buffer full !**

When the TG77 attempted to receive or transmit a large amount of MIDI data, its handling capacity was exceeded.

**MIDI data error !**

An error occurred when receiving MIDI data.

**MIDI checksum err !**

An error occurred when receiving bulk data.

**Device number is off !**

Since the device number is off, bulk data cannot be transmitted or received.

**Device number mismatch !**

Since the device numbers did not match, the bulk data was not received.

### Data card

**Data card not ready !**

The data card is not correctly inserted into the slot.

**Card protected !**

Since the memory protect switch of the card is on, data cannot be saved to the card.

**Illegal format !**

The card is the wrong format.

**Verify error !**

The data was not correctly saved.

### Wave card

**Wave card not ready !**

The wave card is not correctly inserted into the slot.

**Different wave card (ID= ) !**

The wave card which is inserted is not the one used by the voice or multi.

**ID Number mismatch !**

A multi includes voices which use two or more wave cards.

### Battery

**Change internal battery !**

The internal backup battery needs to be replaced.

**Change card battery !**

The card backup battery needs to be replaced.

<b>Other</b>
--------------

**Use bank D !**

4 element voices can be stored (or copied) only to bank D.

**Illegal mark !**

You attempted to mark a display which does not allow marking.

## Multi data blank chart

MULTI DATA		Multi Name												Date			
Voice Name	01				02				03				04				
	05				06				07				08				
	09				10				11				12				
	13				14				15				16				
MIDI Channel		01	02	03	04	05	06	07	08	09	10	11	12	13	14	15	16
Voice Volume																	
Voice Tuning																	
Voice Note Shift																	
Voice Static Pan																	
Voice Output Select																	
Voice Individual Output																	
Assign Mode (DVA/SVA)																	
AFM Max Elements																	
AWM Max Elements																	
Effect	Mode	Stereo Mix 1				Stereo Mix 2											
		Mod. Effect 1				Mod. Effect 2				Rev. Effect 1				Rev. Effect 2			
Effect Type																	
Effect Balance																	
Output Level																	
Parameter 1																	
Parameter 2																	
Parameter 3																	
Parameter 4																	



# Specifications

**Tone generator:** Realtime Convolution and Modulation (RCM)

AWM2: 16 bit linear waveform data, maximum 48 kHz sampling frequency

AFM: 6 operators, 45 algorithms, 3 feedback loops, 16 waveforms, modulation from AWM output

Filter: Time variant IIR (infinite impulse response) digital filters, 2 filters for each element (maximum of 8 filters per voice)

Maximum simultaneous notes: 16 notes AWM + 16 notes AFM

Maximum simultaneous timbres: 16

Note assignment: Last note priority, DVA (dynamic voice allocation), SVA (static voice allocation)

**DSP effects:** (reverb effect + modulation effect) × 2

Reverb effects: 40 types

Modulation effects: 4 types

**Memory:**

Preset memory: 128 voices, 16 multis

Internal memory: 64 voices, 16 multis

Waveform memory: 2 Mwords (4 Mbytes), 112 sounds

Card slots: parameter data × 1, waveform data × 1

**Controllers:**

Switches: Power on/off, VOICE, MULTI, UTILITY, EDIT/COMPARE, COPY, MEMORY, EF.BYPASS, SHIFT, function keys F1–F8, EXIT, BANK/SELECT, ELEMENT, OPERATOR, PAGE ◀, PAGE ▶, JUMP/MARK, -1/NO, +1/YES, cursor Δ ▽ ◀ ▶, numeric keypad 0–9, minus (-), ENTER

Rotary controls: VOLUME (dual concentric, OUTPUT 1/OUTPUT 2), LCD contrast (on rear panel)

**Sliders:** DATA ENTRY

**Display:**

LCD: 240 × 64 pixels (with backlight)

LED: red × 4

**Terminals:**

Audio output: OUTPUT 1/1+2 (L/MONO, R), OUTPUT 2 (L, R), PHONES, INDIVIDUAL OUTPUT 1–8

MIDI: IN, OUT, THRU

**Power requirements:**

US and Canadian models: 120V

General model: 220–240V

**Power consumption:**

US and Canadian models: 28W

General model: 28W

**Dimensions:**

3U: 480(W) × 132(H) × 390(D) mm  
(18-7/8 × 5-1/4 × 15-1/4 inches)

**Included items:** MIDI cable (3m) × 1

**Weight:** 8 kg (17 lb 10 oz)

**Output levels:** measured with a single note (AFM) 1 kHz sine wave, all terminals connected, and volume at maximum

**Individual outputs:** +5 dBm (10 kΩ)

**Headphone:** +5 dBm (150 Ω)

**Stereo outputs:** -1 dBm (10 kΩ)

*\*Specifications and appearance are subject to change without notice.*

# Index

- AFM and AWM voices 14
- AFM element, copy 116, EG 124, filter 130, initialize 134, job directory 114, LFO 127, oscillator 120, pitch EG 128, recall 136, what is an 56
- AFM waveform used as an AWM waveform 138
- AWM element, copy 137, EG 140, filter 145, initialize 146, job directory 137, LFO 143, output 141, pitch EG 144, sensitivity 142, waveform set 138, what is an 52
- AWM waveform input into an AFM algorithm 118
- Aftertouch pitch bend 108
- Algorithm 115, external input 118, form 117, input level 119, what is an 55
- Alternate assign of drum waveforms 149
- Alternate on/off, in a drum voice 77
- Amplitude modulation depth, AFM 127, AWM 143
- Amplitude modulation sensitivity, AFM 126, AWM 142
- Appendix 181
- Assign mode, multi 165
- Attack of a voice, adjusting the 72
- Attack, AWM EG mode 140
  
- Band pass filters 131
- Blank chart for multi data 192
- Bulk dump 177
- Bypass effect 39
  
- Card utility 178
- Card waveforms, note when using 138
- Card, format 179, load from 179, save to 178
- Channel in a multi 35
- Channel set 174
- Character data, how to enter 30
- Common data, element detune 90, element dynamic pan 93, element level 90, note limit 92, note shift 91, output group select 97, random pitch 98, velocity limit 92, voice job directory 90
- Compare, during multi edit 159, during voice edit 58, 87
- Confirm on/off for editing, 172
- Connections 4
- Controller set, drum 150, modulation 108, other 110, pan 109, pitch bend 108
- Controllers, using 70, view voice 83
  
- Copy, AFM filter 130, AWM element 137, element 116, operator 116, multi 156, pan data 95, voice 83
- Curve, velocity 171
- Cutoff frequency, filter, 131, EG 133, scaling 133
  
- DSP effects 16
- Data, how to enter 28
- Demo songs, how to load and play 8
- Demo utility 180
- Detune, AFM oscillator 120
- Device number 174
- Directory, multi 155, voice 82
- Drum voice, job directory 148, how to edit 76
- Dump, bulk data 177
- Dynamic pan 16
- Dynamic voice allocation 165
  
- Edit a voice, from inside multi edit mode 44, 49
- Edit confirm 172
- Edit mode, multi 157, voice 85
- Edit element dynamic pan 94
- Editing, the process of voice 58
- Effect bypass 39
- Effect mode 38
- Effect set, drum 150, multi 164
- Effect, copy 100, set (voice common) 98, mode select 99, modulation 100, reverb 102
- EG, AFM 122, AWM 140, filter 133, pan 96, pitch (AFM) 128, pitch (AWM) 144
- Element, detune (voice common) 91, dynamic pan (voice common) 93, level (voice common) 90, on/off 88, select 88, what is an AWM 52, what is an AFM 56
- Elements 14, in a voice 50
- Entering data 28
- Error messages 190
- Exclusive data dump 177
- External input, into AFM algorithm 118
  
- FM synthesis, basics of 54
- Feedback, in AFM algorithm 117
- Filter modulation depth, AFM 127
- Filter, AFM 130, AWM 145

- Fixed frequency mode, for AWM element waveform 138
- Form, algorithm 117
- Format card 179
- Frequency, AFM oscillator 120, AWM element waveform 138
- Front panel 18
  
- Greeting message 173
- Group, see Output group
  
- High pass filters 131
- Hold time, AWM EG 140
- How to setup and play 4
- Hybrid synthesis 12
  
- Individual output 17, how to use an 40, select (voice) 111, select (multi) 165
- Initial phase, AFM LFO 127, AFM operator 120
- Initialize AFM element 134, AWM element 146, drum voice 151, multi 34, 167, voice 112
- Input level, in an AFM algorithm 119
- Introducing the TG77 3
  
- Job, how to select a 24
- Job directory 24, multi edit 159
- Jump function 26
- Jump numbers for voice editing inside multi mode 46
  
- Key note number, drum waveform 149
- Key splits, see Note limit
- Keypad, how to use the numeric 30
  
- Level scaling, AFM operator 123, AWM 142
- Level, drum waveform 149
- LFO, AFM (main) 127, AFM (sub) 127, AWM 143, controlling a filter 132, of a voice 68
- Limit, note (voice common) 92, velocity (voice common) 92
- Load from card 179
- Low pass filters 131
  
- Marked page, jump to a 26
- Master tuning 171
- Micro tuning 105, copy 107, edit 106, name 108
- MIDI controller, see Controller
- MIDI utility 174
- Mode, voice 50
- Modulation effect, see Effect
- Modulation, controller set 108
- Monophonic voice modes 89
  
- Multi data blank chart 192
- Multi mode 33
- Multi, copy 156, directory 155, edit mode 157, select 155, play mode 153
  
- Name, drum voice 151, micro tuning 108, multi 42, 164, pan 97, voice 74, 111
- Noise, input to an AFM algorithm 118
- Note limit (voice common) 92
- Note on/off (all, odd, even) 174
- Note shift, for entire TG77 171, multi 36, 162, voice common 91
- Numeric keypad, how to use 30
  
- Off voice (multi voice select) 161
- Operator, AFM, copy 116, EG 122, on/off 115, oscillator 120, output 124, select 115
- Oscillator, AFM 120
- Output group 38, drum waveform 149, select (voice common) 97, select (multi voice) 163
- Output, AFM operator 124, AWM 141, individual (voice) 40, 111, individual (multi) 165
  
- Page number, jump to a 26
- Pan, controller set 109, copy 95, drum waveform 149, element dynamic (voice common) 93, preset pan data 94, edit 94, EG 96, name 97, voice in multi 37, 163
- Phase sync, AFM oscillator 120
- Phase, AFM LFO 127, AFM oscillator 120
- Pitch EG, AFM 128, AWM 144
- Pitch bend, adjusting the range 70, controller set 108
- Pitch modulation depth, AFM (main) 127, AFM (sub) 128, AWM 143
- Pitch modulation sensitivity, AFM 126, AWM 143
- Pitch, random (voice common) 98
- Polyphonic voice modes 89
- Polyphony 15
- Portamento (voice common) 98
- Preset drum voices, key assignments of 187,
- Preset multis, list of 11
- Preset voices, explanation of 184, list of 6
- Preset waveform list 139
- Program change 175, table edit 176
- Protect, bulk 174
  
- RAM card, see Card
- Random pitch (voice common) 98
- Rate scaling, AFM operator 123, AFM pitch EG 128, AWM pitch EG 144, filter EG 134
- Rate velocity switch, AFM 126, AWM 142

## APPENDIX

- RCM hybrid synthesis 12, suggestions for using 188
- Rear panel 22
- Recall, AFM element 136, multi 168, voice 113, 136, 147, 152
- Reference section 79
- Resonance, filter 132
- Reverb editing (voice) 62
  
- Save to card 178
- Scales, see Micro tuning
- Scaling, AFM filter cutoff 133, AFM filter EG rate 134, AFM operator EG rate 123, AFM level 125, AWM rate 140, AWM level 142
- Select, voice 4, 82, multi 155
- Sensitivity, AFM 126, AWM 142
- Sequencer, using the TG77 with a 10
- Slider, how to use the data 29
- Source, pan 95
- Specifications of the TG77, 193
- Split keyboard, see Note limit
- Static pan, drum 149
- Static voice allocation 166
- Store, voice 59, 74, multi 42, 159
- Synthesis techniques using RCM 12
- Synthesis, the basics of FM 54
- System exclusive device number 174
- System utility 171
  
- Temperament, see Micro tuning
- Tone of a voice, how to edit the 64
- Transpose, see Note shift
- Tuning, drum waveform 149, master 171, micro 105, multi voice 162
- Tutorials, how to edit a voice 49, how to use multi mode 33
  
- Utility mode 169
  
- Velocity curve 171
- Velocity limit (voice common) 92
- Velocity sensitivity, AFM 126, AWM 142
- Velocity set 171
- Velocity switch, AFM pitch EG 128, AWM rate 142, AWM pitch EG 144
- Vibrato, how to edit 68, using a controller for 70
- View, voice controllers 83
- Voice edit mode, how organized 60
- Voice editing, from inside multi edit mode 44, the process of 58
- Voice mode, determines the number of elements 50, select 89
- Voice, compare 87, controller view 83, copy 83, directory 82, edit mode 85, initialize 112, list of preset 6, mode select 89, name 111, play mode 81, recall 113, 147, receive channel 174, select 4, 82, select in a multi 160, store 87, volume (drum) 148, what is a 50
- Voices in a multi, tuning 162, volume 161.
- Volume, drum voice 148, low limit 110, low limit (drum) 150, voice in multi 36, 161
  
- Wave data set (drum) 148
- Waveform, AFM oscillator 120, AWM element 138, list of AFM preset 139

For information, please contact our nearest subsidiary or the authorized distributor listed below.

Pour plus de détails, veuillez vous adresser au concessionnaire ou distributeur pris dans la liste suivante le plus proche de chez vous.

Informationen erhalten Sie bei unseren unten aufgeführten Niederlassungen und Vertragshändlern in den jeweiligen Bestimmungsländern erhältlich.

Para más informaciones, póngase en contacto con nuestra subsidiaria o distribuidor autorizado enumerados a continuación.

## NORTH AMERICA

### CANADA

**Yamaha Canada Music Ltd.**  
135 Milner Avenue, Scarborough, Ontario, M1S 3R1,  
Canada  
Tel: 416-298-1311

### U.S.A.

**Yamaha Corporation of America,  
Audio, Guitar, and Synthesizer Division**  
6600 Orangethorpe Ave., Buena Park, Calif. 90620,  
U.S.A.  
Tel: 1-800-443-2232

## MIDDLE & SOUTH AMERICA

### MEXICO

**Yamaha De Mexico S.A. De C.V.,  
Departamento de ventas**  
Javier Rojo Gomez No. 1149, Col. Gpe Del Moral,  
Deleg. Iztapalapa, 09300 Mexico, D.F.  
Tel: 686-06-33

### BRASIL

**Yamaha Musical Do Brasil LTDA.**  
Ave. Reboucas 2636, São Paulo, Brasil  
Tel: 55-11 853-1377

### PANAMA

**Yamaha De Panama S.A.**  
Edificio Interseco, Calle Elvira Mendez no. 10, Piso  
3, Oficina #105, Ciudad de Panama, Panama  
Tel: 507-69-5311

### OTHER LATIN AMERICAN COUNTRIES AND CARIBBEAN COUNTRIES

**Yamaha Music Latin America Corp.**  
6101 Blue Lagoon Drive, Miami, Florida 33126,  
U.S.A.  
Tel: 305-261-4111

## EUROPE

### THE UNITED KINGDOM/IRELAND

**Yamaha-Kemble Musics (U.K.) Ltd.**  
Sherbourne Drive, Tilbrook, Milton Keynes, MK7  
8BL, England  
Tel: 0908-366700

### GERMANY/SWITZERLAND

**Yamaha Europa GmbH.**  
Siemensstraße 22-34, D-2084 Rellingen, F.R. of  
Germany  
Tel: 04101-3030

### AUSTRIA/HUNGARY

**Yamaha Music Austria GmbH.**  
Schletergasse 20, A-1100 Wien Austria  
Tel: 0222-60203900

### THE NETHERLANDS

**Yamaha Music Benelux B.V.,  
Verkoop Administratie**  
Kanaalweg 18C, 3526KL, Utrecht, The Netherlands  
Tel: 030-828411

### BELGIUM/LUXEMBOURG

**Yamaha Music Benelux B.V.,  
Administration des Ventes**  
Rue de Bosnie 22, 1060 Bruxelles, Belgium  
Tel: 02-5374480

### FRANCE

**Yamaha Musique France, Division Produits  
Professionnels**  
BP 70-77312 Marne-la-Vallée Cedex 2, France  
Tel: 01-64-61-4000

### ITALY

**Yamaha Musica Italia S.P.A., Gombo Division**  
Viale Italia 88, 20020 Lainate (Milano), Italy  
Tel: 02-937-4081

### SPAIN

**Yamaha-Hazen Electronica Musical, S.A.**  
Jorge Juan 30, 28001, Madrid, Spain  
Tel: 91-577-7270

### PORTUGAL

**Valentim de Carvalho CI SA**  
Estrada de Porto Salvo, Paço de Arcos 2780 Oeiras,  
Portugal  
Tel: 01-443-3398/4030/1823

### GREECE

**Philippe Nakas S.A.**  
Navarinou Street 13, P. Code 10680, Athens, Greece  
Tel: 01-364-7111

### SWEDEN

**Yamaha Scandinavia AB**  
J.A. Wettergrens gata 1, Box 30053, 400 43  
Göteborg, Sweden  
Tel: 031-496090

### DENMARK

**Yamaha Scandinavia Filial Danmark**  
Finsensvej 86, DK-2000 Frederiksberg, Denmark  
Tel: 31-87 30 88

### FINLAND

**Fazer Music Inc.**  
Länsituulentie 1A, SF-02100 Espoo, Finland  
Tel: 90-435 011

### NORWAY

**Narud Yamaha AS**  
Østerndalen 29, 1345 Østerås  
Tel: 02-24 47 90

### ICELAND

**Páll H. Pálsson**  
P.O. Box 85, Reykjavik, Iceland  
Tel: 01-19440

### EAST EUROPEAN COUNTRIES (Except HUNGARY)

**Yamaha Europa GmbH.**  
Siemensstraße 22-34, D-2084 Rellingen, F.R. of  
Germany  
Tel: 04101-3030

### UNION OF SOVIET SOCIALIST REPUBLICS

**Yamaha Corporation, Asia Oceania Group**  
Nakazawa-cho 10-1, Hamamatsu, Japan 430  
Tel: 81(Country Code)-53-460-2311

## AFRICA

### MOROCCO

**Yamaha-Hazen Electronica Musical, S.A.**  
Jorge Juan 30, 28001, Madrid, Spain  
Tel: 91-577-7270

### OTHER COUNTRIES

**Yamaha Musique France, Division Export**  
BP 70-77312 Marne-la-Vallée Cedex 2, France  
Tel: 01-64-61-4000

## MIDDLE EAST ASIA

### ISRAEL

**R.B.X. International Co., Ltd.**  
P.O. Box 11136, Tel-Aviv 61111, Israel  
Tel: 3-298-251

## OTHER COUNTRIES

**Yamaha Musique France, Division Export**  
BP 70-77312 Marne-la-Vallée Cedex 2, France  
Tel: 01-64-61-4000

## ASIA

### HONG KONG

**Tom Lee Music Co., Ltd.**  
15/F, World Shipping Centre, Harbour City, 7  
Canton Road, Kowloon, Hong Kong  
Tel: 3-722-1098

### INDONESIA

**PT. Nusantik**  
Gedung Yamaha Music Center, Jalan Jend. Gatot  
Subroto Kav. 4, Jakarta 12930, Indonesia  
Tel: 21-520-2577

### KOREA

**Cosmos Corporation**  
131-31 Neung-dong, Sungdong-ku, Seoul, Korea  
Tel: 2-466-0021-5

### MALAYSIA

**Yamaha Music Malaysia, Sdn., Bhd.**  
16-28, Jalan SS 2/72, Petaling Jaya, Selangor,  
Malaysia  
Tel: 3-717-8977

### PHILIPPINES

**Yupango Music Corporation**  
339 Gil J. Puyat Avenue, Makati, Metro Manila  
1200, Philippines  
Tel: 2-85-7070

### SINGAPORE

**Yamaha Music Asia Pte., Ltd.**  
80 Tannery Lane, Singapore 1334, Singapore  
Tel: 747-4374

### TAIWAN

**Kung Hsue She Trading Co., Ltd.**  
KHS Fu Hsing Building, 322, Section 1, Fu-Hsing  
S Road, Taipei 10640, Taiwan, R.O.C.  
Tel: 2-709-1266

### THAILAND

**Siam Music Yamaha Co., Ltd.**  
933/1-7 Rama 1 Road, Patumwan, Bangkok,  
Thailand  
Tel: 2-215-0030

### THE PEOPLE'S REPUBLIC OF CHINA AND OTHER ASIAN COUNTRIES

**Yamaha Corporation, Asia Oceania Group**  
Nakazawa-cho 10-1, Hamamatsu, Japan 430  
Tel: 81(Country Code)-53-460-2311

## OCEANIA

### AUSTRALIA

**Yamaha Music Australia Pty. Ltd.**  
17-33 Market Street, South Melbourne, Vic. 3205,  
Australia  
Tel: 3-699-2388

### NEW ZEALAND

**Music Houses of N.Z. Ltd.**  
146/148 Captain Springs Road, Te Papapa, Auckland  
New Zealand  
Tel: 9-640-099

### COUNTRIES AND TRUST TERRITORIES IN PACIFIC OCEAN

**Yamaha Corporation, Asia Oceania Group**  
Nakazawa-cho 10-1, Hamamatsu, Japan 430  
Tel: 81(Country Code)-53-460-2311

**HEAD OFFICE** Yamaha Corporation, Electronic Musical Instrument Division  
Nakazawa-cho 10-1, Hamamatsu, Japan 430  
Tel: 81(Country Code)-53-460-2445

## SERVICE

This product is supported by YAMAHA's worldwide network of factory trained and qualified dealer service personnel. In the event of a problem, contact your nearest YAMAHA dealer.

**YAMAHA**

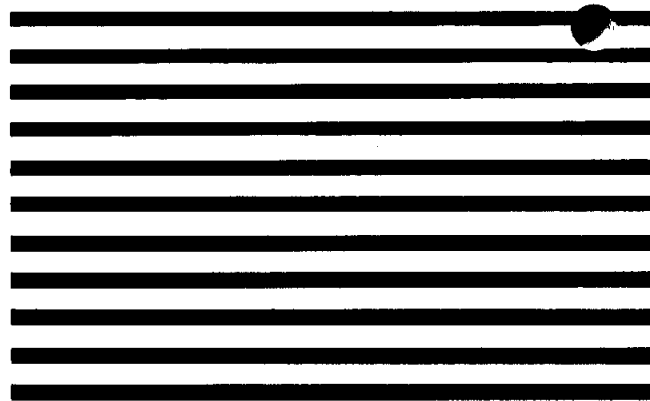

YAMAHA CORPORATION  
PO Box 1, Hamamachi, Japan

VJ96790 91090.6 R5 ITP Printed in Japan